

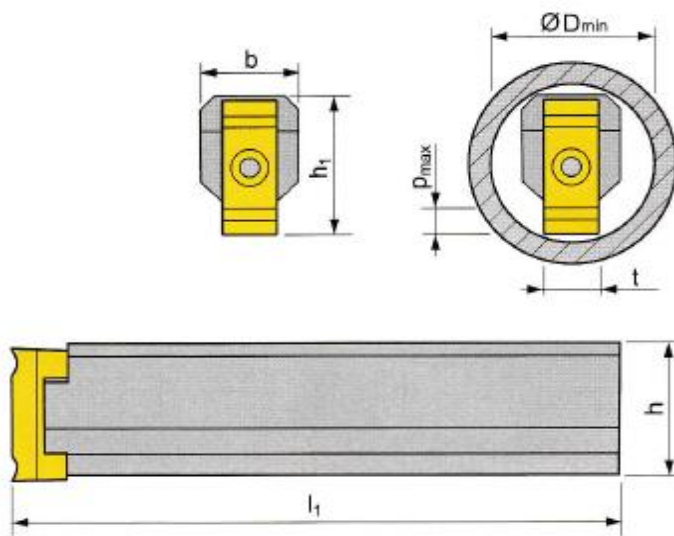

(spiebaan)-steekgereedschap

System PHZ/2 / HOUDERS

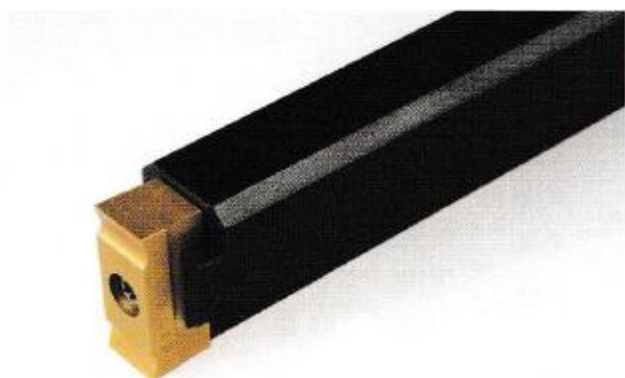

Houder	h	h1	b	l1	T	D min	P max	Kg	Onderdelen:	Inserts
PHZ/2 - 3625-14	36	37,5	25	300	14	44	8	0,23	SH 23	HZ/2 1414..
					16	44	9			HZ/2 1616..
PHZ/2 - 4832-18	38	50	32	400	18	58	12	1,19	SH 24	HZ/2 1818..
					20	58	13			HZ/2 2020..

Onderdelen

Type:	Schroefje	Schroevendraaier
		
SH 23	5513 020-14	TX 225 Plus
SH 24	5513 021-14	DMN 3124

Houder	Prijs per stuk:
PHZ/2 - 3625-14	op aanvraag
PHZ/2 - 4832-18	op aanvraag

(spiebaan)-steekgereedschap
Systeem PHZ 2/ WISSELPLATEN

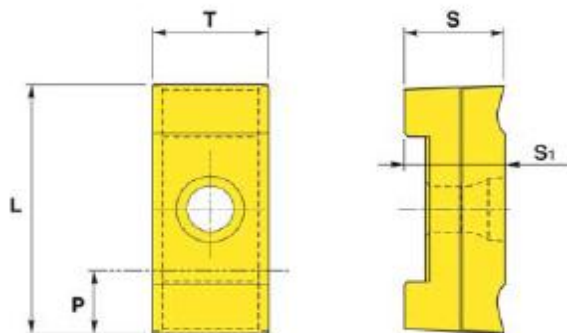

Afm.	s	s1	l	p	t
1414	13,90	14,00	36,00	8,00	14,00
1616	13,90	13,00	36,00	9,00	16,00
1818	15,90	16,00	45,00	12,00	12,00
2020	15,90	15,00	45,00	13,00	13,00

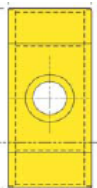
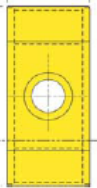
333TN= HSS + coating PVD	ISO	Prijs per stuk:	Breedte:	Tolerantie:		Voeding:	
			t	min	max	ap min	ap max
							
	HZ/2 1414 C11	op aanvraag	14,00	0,095	0,205	0,08	0,30
	HZ/2 1616 C11	op aanvraag	16,00	0,095	0,205	0,08	0,30
	HZ/2 1818 C11	op aanvraag	18,00	0,095	0,205	0,09	0,35
	HZ/2 2020 C11	op aanvraag	20,00	0,110	0,240	0,09	0,35
333TN= HSS + coating PVD							
	HZ/2 1414 H7	op aanvraag	14,00	0,000	0,018	0,08	0,30
	HZ/2 1616 H7	op aanvraag	16,00	0,000	0,018	0,08	0,30
	HZ/2 1818 H7	op aanvraag	18,00	0,000	0,018	0,09	0,35
HZ/2 2020 H7	op aanvraag	20,00	0,000	0,021	0,09	0,35	
333TN= HSS + coating PVD							
							
	HZ/2 1414 P9	op aanvraag	14,00	-0,061	-0,018	0,08	0,30
	HZ/2 1616 P9	op aanvraag	16,00	-0,061	-0,018	0,09	0,35
	HZ/2 1818 P9	op aanvraag	18,00	-0,061	-0,018	0,10	0,40
	HZ/2 2020 P9	op aanvraag	20,00	-0,074	-0,022	0,10	0,45